

Article number: 0110067

Description: Retaining ring JS 50x2,5  
Springsteel

## Measures

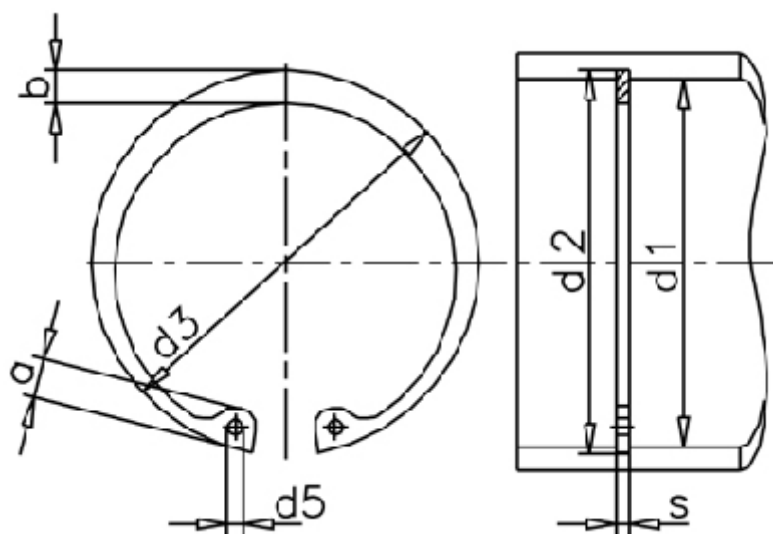

a max	= 7.5	Description	= JS 50	t	= 1.50
AN mm <sup>2</sup>	= 243	FN kN	= 40.5	tol	= 0.30
B	= 1.57	FRg kN	= 19.0	tol	= +1,10 -0,46
b	= 4.6	FR kN	= 95.5	tol	= -0.07
d1	= 50	g	= 2.0	Tong	= ZGJ-3
d2	= 53.0	m min	= 2.65	Weight kg/1000	= 8.8
d3	= 54.2	Nominal drive	= 4.5		
d5 min	= 2.5	s	= 2.50		